

NFPA-20 Fire Pump

2-383-9C

ULV-50

Compact Residential Package
 Design Condition: 50GPM @ 85PSI

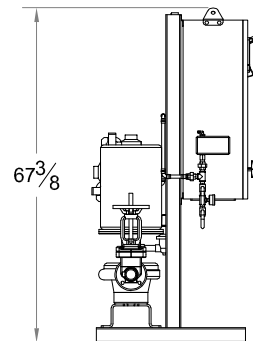
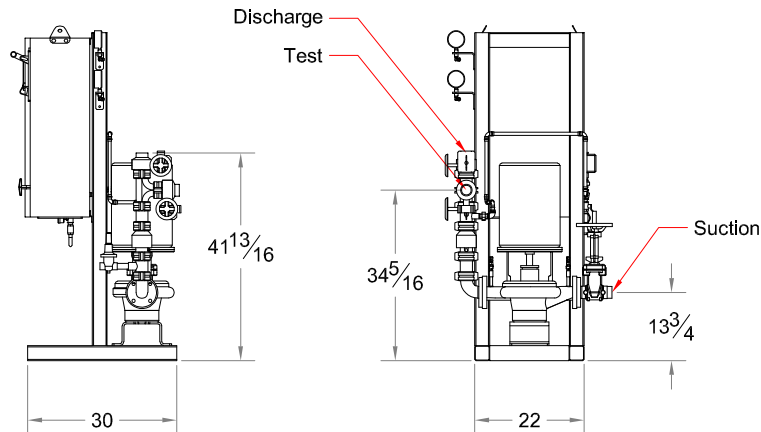
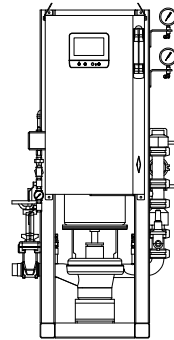
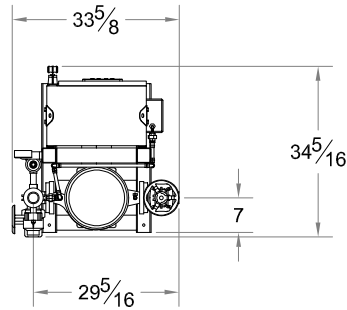
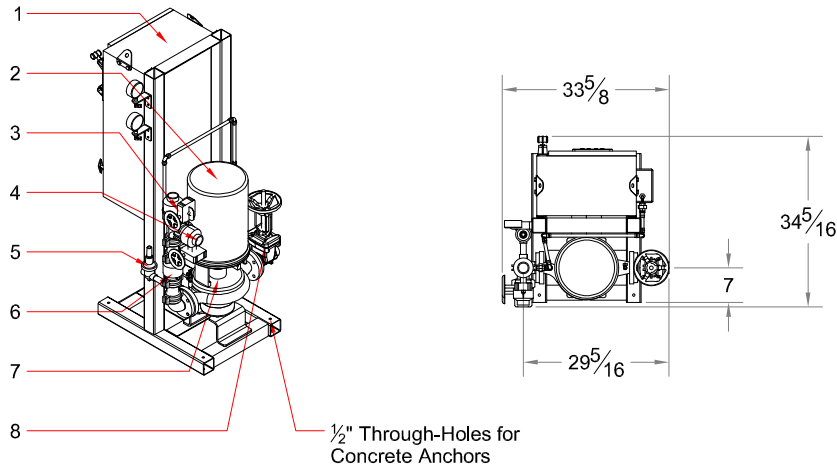

System Components per NFPA-20

System Specifications:

- Motor
- 10 Horsepower Electric
- 230 Volt, 46 Amp
- Single Phase
- 3450 RPM

Pump

- UL Vertical Inline Fire Pump
- 2" Suction (Grooved)
- 2" Discharge (Grooved)
- 2" Test Connection (Grooved)
- 175 PSI max working pressure

System Components (UL Listed by Manufacturer)

- 1- Limited Service Fire Pump Controller
- 2- Electric Motor (UL Recognized)
- 3- Discharge Butterfly Valve (Monitored)
- 4- Test Connection Butterfly Valve (Monitored)
- 5- Case Relief Valve
- 6- Check Valve
- 7- Vertical Inline Fire Pump
- 8- Suction OS&Y (Monitored)

Dimensions

- 35" Depth
- 68" Height
- 34" Width

*All dimensions are approximate and subject to change without notice.