

LSF-500CIF

NFPA-13D Residential Package

Maximum Suction Pressure: 72PSI

System Specifications

Motor

- 5 horsepower electric
- 240 Volt, 21.5 Amp
- Single Phase
- 3450 RPM

Pump

- High pressure cast iron volute
- Machined bronze impeller
- 1½" Suction
- 1¼" Discharge
- 150 PSI Max Working Pressure

Discharge Manifold

- Check Valve
- Zero to 100 PSI pressure gauge
- 40/60 pressure switch
- Isolation ball valve

Controls

- 240 Volt
- Minimum run timer
- Pressure switch operated contactor
- HOA toggle switch (Hand, Off, Auto)

Dimensions (approximate)

- 22⁷/₁₆" Length
- 19¹/₂" Height
- 14" Width
- 135 pounds

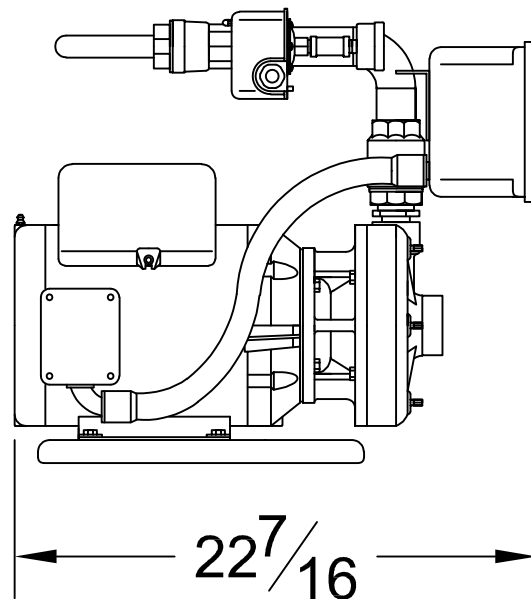
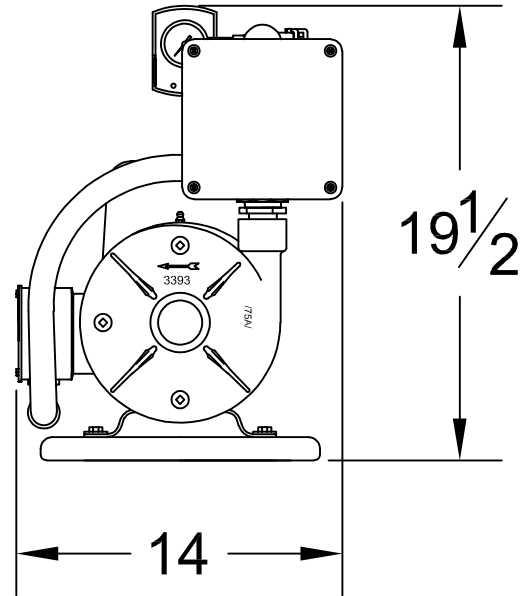

Performance

Performance values based on multiple pump tests. Not for certification purposes.

GPM	0	35	40	45	50	55	60	65
PSI	74	69	68	67	65	63	61	58