

# O&M INSTRUCTION MANUAL

## POTABLE WATER MODEL



**HOME HYDRANT<sup>®</sup>**  
**TALCO FIRE SYSTEMS**

U.S. PATENTS #8,678,032 & #8,905,069

# Table of Contents

<b>Overview of the Home Hydrant PW.....</b>	<b>I</b>
<b>Safety Information.....</b>	<b>II</b>
<b>Home Hydrant Carry Instructions.....</b>	<b>III</b>
<b>Section 1 – Preparation.....</b>	<b>1</b>
<b>Section 2 – Installation.....</b>	<b>2</b>
2.1 – Proximity to Existing Walls	
2.2 – Float Valve Installation	
2.3 – Discharge Piping	
2.4 – Overflow	
2.5 – Tank Fill	
2.6 – Control Box Preparation	
2.7 – System Wiring Instructions	
<b>Section 3 – Start-Up Procedures.....</b>	<b>4</b>
3.1 – Air Bleed Procedure	
3.2 – Discharge Valve	
3.3 – Pump First Start	
3.4 – Switch to Auto	
3.5 – Pump Start-Pressure Check	
3.6 – Adjusting the Pressure Tank Air Charge	
3.7 – Installing the Pressure Tank	
3.8 – Filling the Sprinkler System and Pressure Tank	
3.9 – House Piping Air Bleed Procedure	
3.10 – Switch to Auto	
3.11 – Testing the Operation	
3.12 – Checking and setting the Timer	
3.13 – Finishing the Start-Up	
<b>Run Timer and Pressure Tank Overview and Adjustments</b>	
<b>Section 4 – Testing Procedures.....</b>	<b>7</b>
4.1 – Home Hydrant Testing Information	
4.2 – Home Hydrant Isolation and Testing	
4.3 – Home Hydrant Return to Normal Operation	
4.4 – Pressure Tank Isolation	
4.5 – Pressure Tank or System Drain	
4.6 – Checking the Air Charge	
4.7 – Re-Integrating the Pressure Tank	
4.8 – Completing the Testing	
<b>Section 5 – Troubleshooting.....</b>	<b>8</b>
5.1 – Pump Won’t Start	
5.2 – Pump Makes Churn Pressure but Won’t Shut Off	
5.3 – Pump Runs but the Pressure is Too Low/the Pump Doesn’t Shut Off	
5.4 – Pump Makes “Gravelly” or “Grumbling” Noise	
5.5 – Suction Pipe is Leaking	
5.6 – Tank is Leaking	
5.7 – Pump is “Broken”	
<b>Pressure Switch Adjustment (Factory Set)</b>	
<b>Home Hydrant Wiring Diagram.....</b>	<b>IV</b>
<b>Warranty Information.....</b>	<b>V</b>

# OVERALL VIEW OF HOME HYDRANT

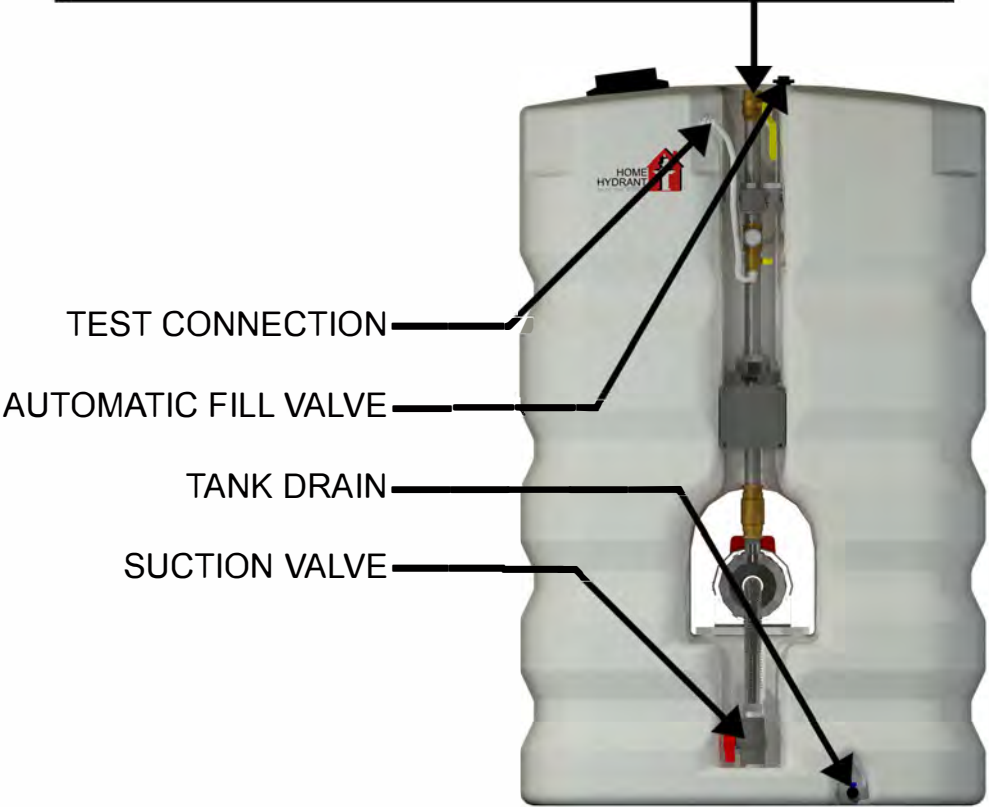
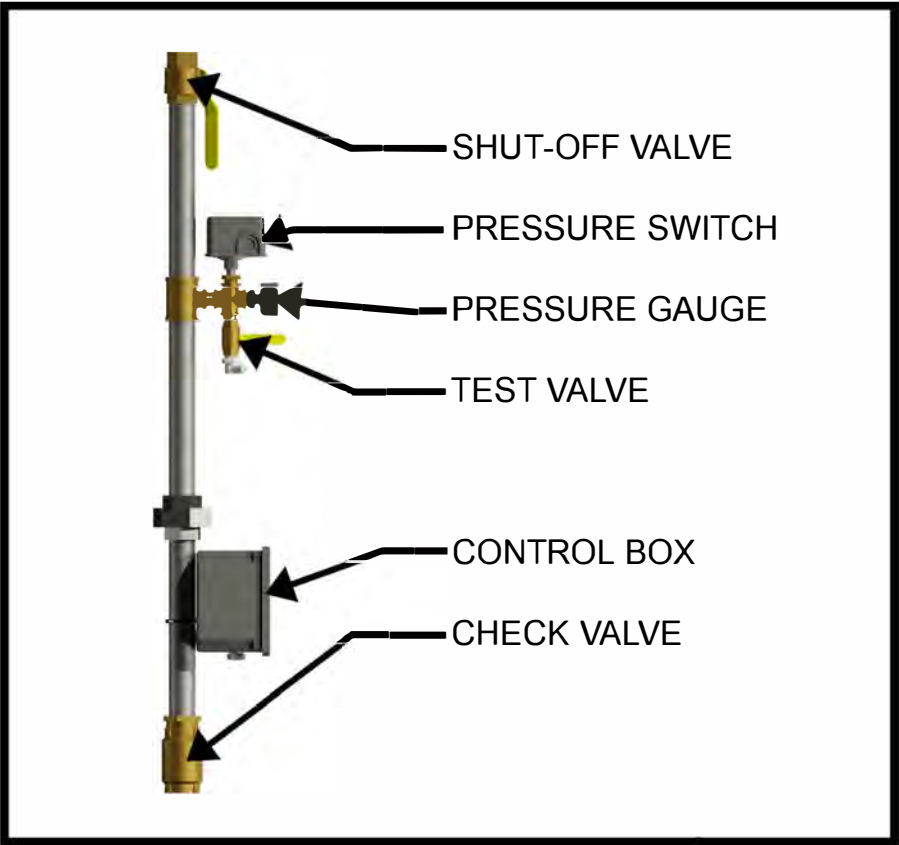

# IMPORTANT SAFETY INFORMATION

**THIS MANUAL IS INTENDED TO ASSIST IN THE INSTALLATION AND OPERATION OF THIS UNIT AND MUST BE KEPT WITH THE UNIT.**

**UNIT NOT DESIGNED FOR USE WITH HAZARDOUS LIQUIDS OR FLAMMABLE GASES. THESE CAN CAUSE FIRE, BURNS, DAMAGE, OR FATALITIES.**

To avoid serious or fatal injury, or major property damage, read and follow all safety instructions in this manual and on the product.

The following **SAFETY SYMBOLS** in the manual or on the product warn of **HAZARDS** that can cause fatality, personal injury, or property damage as described below.



Warns of **ELECTRICAL HAZARDS** that can cause fatality, serious personal injury, or major property damage.



Warns of **NON-ELECTRICAL HAZARDS** that can cause personal injury or property damage.



Warns of common installation mistakes. This symbol may denote both **ELECTRICAL HAZARDS** and **NON-ELECTRICAL HAZARDS**.

## Moving the Home Hydrant

Home Hydrants should be maneuvered and pushed into position while standing upright. They may be slid over solid, flat surfaces without damage to the bottom of the tank. Push only on the tank.

**Do not, under any circumstances, use the suction or discharge piping to lift, pull, push, or support the unit. This can lead to leaks or serious damage. Piping is not a handle.**

When moving the unit over rough or uneven surfaces it is recommended that the unit is carefully and slowly laid on its back, pump and piping facing upwards. Using ratcheting straps, or other similar straps, wrap them around the indentations on each end of the tank. On the four corners at each ratcheting strap pass a rope or strap under the ratcheting strap and tie it in a loop to make a lifting handle. Ensure the ratcheting straps are tight so they do not slip off the tank during the moving operation. Use a pipe or 2x4 passed through the loop to pick unit up to move it.

Unit on its back with ratchet straps and handle loops



Lifting the unit via the handle loops



Lifting the unit via pipe or 2x4 through the handle loops



**Do not store the Home Hydrant unprotected outside.**

**Do not lay the Home Hydrant with the pump and piping facing downward.**

**Do not attempt to move a Home Hydrant that contains water.**

**Do not double stack Home Hydrants.**

**Do not climb or step on the Home Hydrant.**

**Do not strap or secure the Home Hydrant with enough force to bow, crack, split, cut, or otherwise damage the tank.**

## PREPARATION

1.1 Inspect unit for damage. Report any and all damage or suspected damage to carrier or distributor immediately. Contact Talco for additional assistance.



1.2 **Do not, under any circumstances, use the suction or discharge piping to lift, pull, push, or support the unit or other objects. This can lead to leaks or serious damage. Piping is not a handle, hanger, ladder, or step.**



1.3 Electrical supply must be a separate branch circuit with fuses or circuit breakers, wire sizes, etc. per national and local electrical codes. Adhere to all applicable laws, standards, and codes when wiring. Installation by a licensed electrical contractor is recommended. The Home Hydrant is 230V 1PH only. **The pump cannot be safely energized before all installation steps have been completed. Damage will result if a pump is run dry.**

1.4 The TALCO Home Hydrant must be installed in such a manner that the tank is readily accessible for regular maintenance or replacement in case of tank failure. **Do not install the unit in a manner that requires removal of any wall or portion of the structure.**

1.4.1 TALCO FIRE SYSTEMS will not be held liable for any cost that may incur due to removal or replacement of walls, doors, etc. in order to replace the tank or any equipment that may require service or replacement, or fail while in service due to improper installation; including, but not limited to, installation in an unprotected area.



1.5 **Units shall be installed in a location that protects them from direct sunlight, inclement weather in general, and freezing temperatures in particular.** Installation in a secured room is strongly recommended to prevent vandalism or tampering with control settings. Not following the guidelines above may cause the unit to malfunction or fail prematurely.



**1.5.1 Home Hydrant systems are not designed for unprotected outdoor installation or storage.**



1.6 It is imperative that the surface the Home Hydrant is installed on is capable of supporting the weight of the unit when full of water, and is level and solid in nature. Do not install the unit on gravel, dirt, grass, or other substrates which may shift or contain materials which may puncture the tank.

1.6.1 Fresh water weighs approximately 8.34 pounds per gallon. Use caution when deciding where to place a Home Hydrant. **Never attempt to move a unit that is full of water.**

# INSTALLATION



**2.1** Place the Home Hydrant into the desired position. **Do not use the piping as a handle.** Do not place it directly against a wall; leave a gap of approximately 6 inches on all sides if possible. **The front and top must be accessible for use and service.**

**2.2** Install the Float Valve (if required) and connect the incoming water piping. **The bulkhead outer threads are left-handed (counter-clockwise to tighten). The bulkhead inner threads are right-handed (clock-wise to tighten). The inner threads are 3/4" Female NPT.**



**2.2.1** Do not over-tighten the incoming water piping, damage may occur; the Float Valve bulkhead is plastic; Use caution.

**2.2.2** The Float Valve level may need to be adjusted upon installation. For small adjustments the float rod may be carefully bent. For large adjustments the thumb-screw on the valve may be loosened, the valve position adjusted, and the screw re-tightened.



**2.2.3** Hold the Float Valve steady during installation of the water piping so that the float assembly does not spin inside the tank.

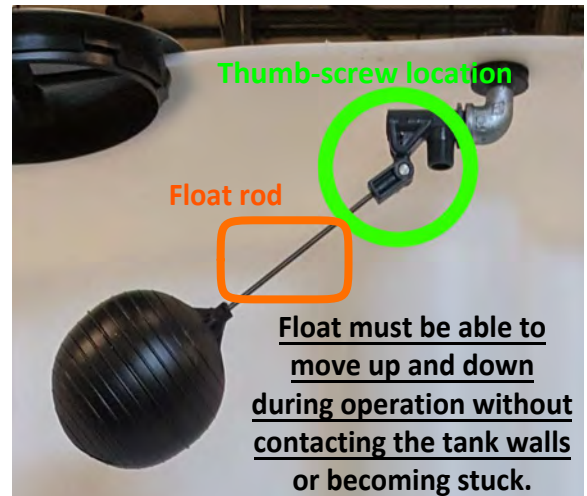

**2.2.4** If allowed by local code, install a disconnecting means and shut-off valve in the fill piping above the Float Valve.



**2.3** Connect the 1-1/4" discharge piping to the sprinkler system. All connecting piping must be supported independently of the Home Hydrant and must be naturally aligned. **If allowed by local code, install an isolation valve and disconnecting means (such as a union) above the Home Hydrant piping. A disconnecting means is strongly recommended.**



**2.3.1** Do not force pipe connections into place. Continuous tension on piping will result in leaks or serious damage.



**2.3.2** Do not install a check valve in the discharge plumbing. The unit is already equipped with a check valve above the pump. Duplication will cause poor operation or damage.



**2.3.3** Always support Home Hydrant piping with a "backup" wrench during installation. Do not rely on thread sealant alone to prevent rotation of piping or valves.

**2.4** Pipe the 1" overflow fitting to a suitable drain. It is recommended that this drain be easily visible in order for an overflow situation to be noticed quickly.



**2.5** Fill the tank with water. Observe the tank for leaks as it fill. **If a leak is observed stop filling the tank and do not put the unit into service.** See the troubleshooting section at the back of this manual for information on fixing leaks.

## INSTALLATION CONTINUED:

2.6 Remove the control box

\ 77

Leave the toggle switch in the "OFF" position throughout the installation process.



2.7 #  
#



2.7.1 Never attempt to connect wires that are electrically charged, this could result in injury, damage, and fatality. Use extreme care.



2.7.2 The incoming power must be 230 volt, single phase only. No other voltage or phase is acceptable.



2.7.3 Do not connect a neutral wire. Home Hydrants do not require a neutral.



2.7.4 Do not attempt to modify the controller wiring or connect any other electrical devices to the controller.



**2.7.5 DO NOT CONNECT INCOMING POWER TO THE PRESSURE SWITCH OR MODIFY THE PRESSURE SWITCH ELECTRICAL CONNECTIONS.**

-  
# ) \ \ u



**2.7.6 DO NOT, UNDER ANY CIRCUMSTANCES, ENERGIZE A PUMP WHICH HAS NOT BEEN PRIMED WITH WATER.**

Starting a pump dry will cause immediate damage to the shaft seals and will void the system warranty.



## START-UP PROCEDURES

**3.1** Bleed the air out of the pump through the ¼" Air Bleed Valve (1) and the ½" Test Valve (2).

**3.2** Close the 1 ¼" Discharge Control Valve at the top of the Home Hydrant manifold (3).

**3.3** Energize the pump by putting the toggle switch in "HAND". The pump should run and build pressure quickly, up to approximately 57 PSI.



**3.3.1** If the unit does not build pressure quickly or if the pump makes excessive noise or vibration return the switch to "OFF" and see the troubleshooting section at the back of this manual.

**3.4** Put the switch in "AUTO". The pump should stop running and the pressure should remain steady.

**3.5** Slowly open the Test Valve (2) while watching the pressure gauge. Take careful note of the pressure at which the pump starts. When the pump starts close the Test Valve and the pump should shut off after approximately 45 Seconds. Repeat this procedure at least twice to confirm the start pressure.

**3.5.1** The start pressure is pre-set during production, but environmental factors such as altitude can affect operation. The start pressure will be approximately 35-42 PSI.

**3.6** Adjust the air charge in the pressure tank to 2 PSI BELOW the start pressure of the pump.



**3.6.1** When checking or adjusting the air pressure in a pressure tank be sure the tank is FULLY EMPTY OF WATER. Any water in the tank will cause an inaccurate reading. It is best to adjust the air charge BEFORE installation of the pressure tank. Refer to page 6 for more information on proper pressure tank installation and setup.

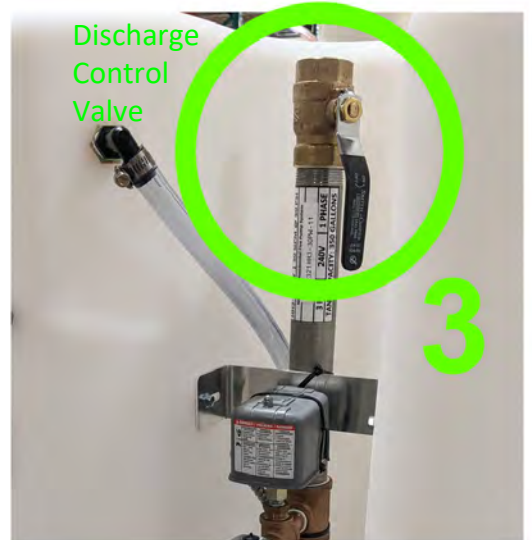
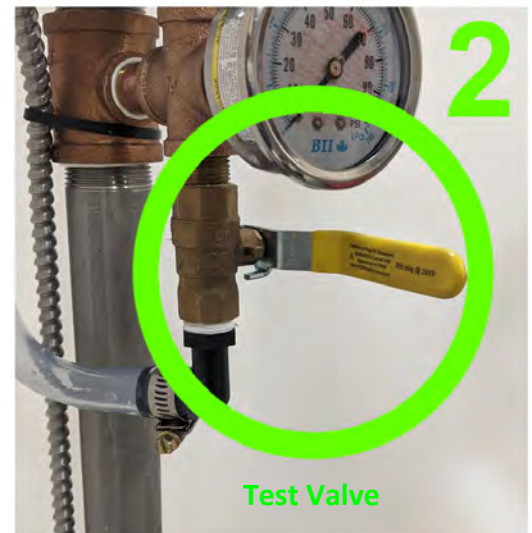
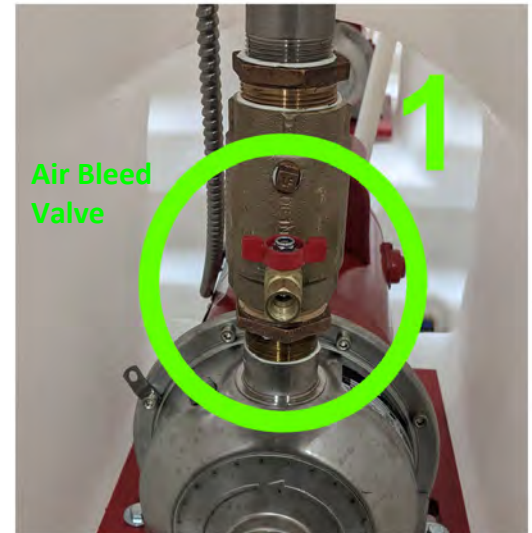

## START-UP PROCEDURES CONTINUED

**3.7** Install the pressure tank into the piping system and open any valves between the pressure tank, house piping, and Home Hydrant, **except for the Discharge Control Valve at the top of the Home Hydrant manifold.**

**3.8** Put the switch into "HAND" so that the pump runs continuously and very slowly open the Discharge Control Valve.



**3.8.1** **Opening the Discharge Control Valve too quickly could shock the pressure tank or other sensitive system components. Open the valve in a slow and controlled manner.**

**3.9** Open a hose bibb, faucet, shower, or other system drain in the home and allow all the air in the piping to escape. If possible, open multiple system drains.

**3.10** When the hose bibb or faucet flows a steady stream of water close it and put the toggle switch into "AUTO". The Home Hydrant should shut off after a short time.

**3.11** Drop the pressure in the system by opening the Test Valve or a system drain in the home until the Home Hydrant starts, then close the valve. Carefully monitor the pressure gauge on the unit. The pressure will slowly climb as the pressure tank fills with water.

**3.12** When the pressure reading on the gauge stops climbing and remains steady at its maximum the pressure tank is full, this will typically be around 57 PSI. If necessary, adjust the timer (page 6, fig. 4) so that the Home Hydrant PW shuts off approximately 10-30 seconds after the pressure gauge stops climbing and the pressure tank is full. This will allow the tank to fill to maximum capacity and for any pressure fluctuations in the system to abate.

**3.12.1** **The Timer is pre-set at approximately 45 seconds, but is adjustable from 6 seconds to 600 seconds. Adjust clockwise to increase the time and counter-clockwise to reduce it.**



**3.12.2** **It is acceptable to carefully adjust the timer while the system is running, but use extreme caution. Do not touch any wires, contacts, or other components when adjusting the timer. Use of a thin, insulated screwdriver is advised.**

**3.13** Test the system several times, re-adjusting the timer as necessary. The set-up is complete if the system is working properly. Contact Talco if additional instruction is required.

# SETTINGS AND ADJUSTMENTS

## ADJUSTABLE RUN TIMER

The control box timer is factory set at approximately 45 seconds. This is well matched to the optional pressure tank sold by Talco (81 gallons), and is a good starting point for larger pressure tanks, or multi pressure tank setups.

The timer works as a "delay-on-break" system, referencing the pressure switch opening and then adding in an adjustable delay before shutoff.

Use caution when setting the timer. A pump that runs for a prolonged period without discharging water is subject to overheating and damage, while a pump with too short of a run time may cycle on and off repeatedly when there is low demand.

It is acceptable to carefully adjust the timer while the system is running, but use extreme caution. Do not touch any wires, contacts, or other components when adjusting the timer. Use of a thin, insulated screwdriver is advised.

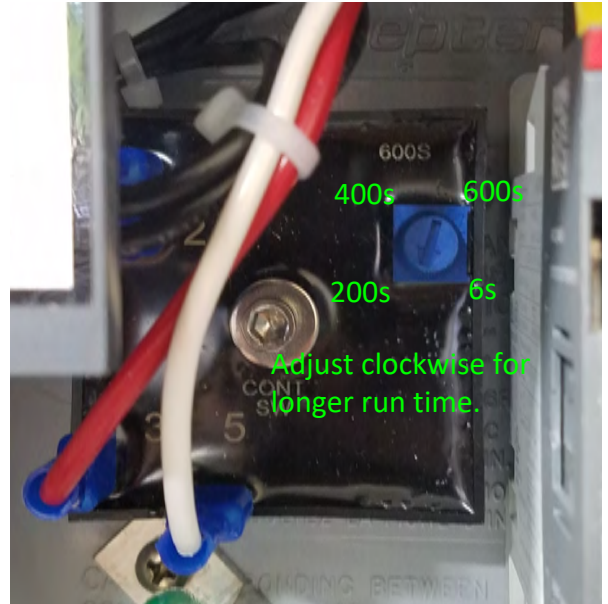

**Adjust clockwise for a longer run timer and counterclockwise for shorter. The minimum is 6 seconds. The maximum is 10 minutes.**

## PRESSURE TANK OVERVIEW

Potable water fire suppression systems utilize a hydro-pneumatic pressure tank, or "bladder tank", installed in the discharge piping. It is strongly recommended that an isolation valve be installed to secure the tank from the system in order for tank maintenance to be performed. It is also strongly recommended that a means to drain the tank be installed while it is isolated so that the air charge can be checked annually or if it is believed the tank has failed. See below for an example of a typical installation.



**The hydro-pneumatic tank will require an air charge of approximately 2 PSI below the cut-in pressure setting of the pump. The air charge is put in and checked with no water pressure in the tank.**

Switch Cut-In	Tank Air Pre-Charge
20 PSI	18 PSI
30 PSI	28 PSI
40 PSI	38 PSI

## TESTING PROCEDURES

### Home Hydrant PW

**4.1** Due to the nature of a combined domestic/fire system a Home Hydrant PW can be considered inherently "self-testing"; however, manual testing is recommended on a periodic basis, primarily as a means to check for any irregular operation of the system. Observe the system carefully as you test it, any unusual noises or changes in operation should be investigated.

**4.2** Close the Discharge Control Valve (1) to isolate the unit from the sprinkler system. Open the system Test Valve (2). The pump should start. Allow the pump to run with the valve open for about 1 minute.

**4.3** Close the system test valve (2) then slowly open the system discharge valve (1). The pump will continue to run until the minimum run time elapses and then shut off. Your system is now ready for automatic operation.



### Pressure Tank

**Check your pressure tank at least once a year!**

**4.4** Isolate the pressure tank from the system.

**4.5** Open the pressure tank drain valve and empty the tank of all water.



**4.5.1** If a drain valve has not been installed then do not isolate the tank from the system. Instead close the Discharge Control Valve at the top of the Home Hydrant piping and open a faucet or hose bibb in the home to drain the entire system, including the pressure tank.

**4.6** Using a standard automotive tire type air gauge, check the air charge in the pressure tank. If the air charge is within a few pounds of 38 PSI then the air charge is appropriate and the tank is likely functioning correctly. **If the air charge is significantly different adjust it to approximately 38 PSI and recheck at least weekly, noting any changes that occur. Pressure tanks can fail internally over time and a fluctuating air charge is a primary symptom.**

**4.7** Close any drain valves and slowly re-open the valves separating the Home Hydrant and pressure tank. Do not open the valves too quickly, as rapid pressure changes may damage the pressure tank.

**4.8** Open a valve in the home and allow any air that was introduced into the piping to escape. If the system is operating correctly the check is complete.

## TROUBLESHOOTING

### 5.1 Pump won't start.

**5.1.1 Check to make sure the breaker hasn't tripped.** Cycle the breaker if necessary. Ensure the breaker is sized appropriately and is of the "slow trip" type.

**5.1.2 System pressure is too high.** Open the test valve and drop the pressure.

**5.1.3 Pressure switch settings are incorrect.** Cut-in is set too low and must be adjusted

**5.1.4 Incorrect incoming power.** Check to make sure the unit is wired 230volt 1phase.

**5.1.5 Pump is turned off inside control box.** The pump will only function in "Auto" or "Hand".

### 5.2 Pump makes churn pressure but won't shut off.

**5.2.1 Pressure switch settings are incorrect.** Cut-out is set too high and must be adjusted.

**5.2.2 System is incorrectly wired.** Ensure that the incoming power is wired per this manual.

**5.2.3 Timer setting is too high.** See page 6 for timer information. Adjust as necessary.

### 5.3 Pump runs but the pressure is too low/the pump doesn't shut off.

**5.3.1 Air in the pump.** Open the bleed valve and test valve to purge any air.

**5.3.2 Incorrect incoming power.** Check to make sure the pump is wired 230volt 1phase.

**5.3.3 Ensure the pump has adequate water.** Ensure the suction valve is open and there is sufficient water in the tank.

### 5.4 Pump makes "gravelly" or "grumbling" noise.

**5.4.1 Air in the pump.** Open the bleed valve and test valve to purge any air.

**5.4.2 Ensure the pump has adequate water.** Ensure the suction valve is open and there is sufficient water in the tank.

**5.4.3 Debris in the pump casing.** Pump removal and inspection is advised.

**5.4.4 Check for leaks in the suction piping.** Ensure the pump is not pulling in air through a leak.

### 5.5 Suction pipe is leaking.

**5.5.1 Flexible piping seals are damaged or displaced.** Close the Suction Valve and remove the flexible piping. Examine the seal placement and condition. If the seals appear cut or damaged try removing them and flipping them over.

**5.5.2 Flex piping connections are too loose or too tight.** Tighten the end-nuts only 1/3 to 2/3 turn past when the gasket seats. Over-tightening can cause seal damage or displacement.



## TROUBLESHOOTING CONTINUED

### 5.6 Tank is leaking

**5.6.1 All Talco Home Hydrant tanks are pressure tested prior to sale.** If a tank is leaking the damage may have been sustained during shipping or installation. **Home Hydrant tanks are polyethylene and can be carefully repaired in the field.** Contact Talco for more information on repair procedures.



**5.6.2 Do not put a leaking tank into service.**

### 5.7 Pump is "broken"



**5.7.1 Stop! Never assume the pump is at fault.** Replacement of a pump is the absolute last resort. Contact Talco for additional assistance before attempting to replace a pump. Most "broken" pumps are maladjusted pressure switches or incorrect wiring.

**5.7.2 The Home Hydrant is designed to make pump removal as easy as possible, should the need arise.**

## PRESSURE SWITCH ADJUSTMENT

The pressure switch has been factory wired and adjusted. In the unlikely event adjustment of the pressure switch is required please note the following:

- A) The large spring affects both the cut-in and cut-out points equally. Turn the adjusting nut clockwise to equally raise the pressure for both.

***Note: If the cut-out pressure has been raised above the maximum pressure of the pump the system will not shut off.***

- B) The small spring controls the differential between cut-in and cut-out pressure. This is factory set for a 15PSI-20PSI differential. Turn the adjusting nut clockwise to increase the cut-out only.

***Note: We do not recommend adjusting the pressure switch without contacting TALCO.***



**HAZARDOUS VOLTAGE: Disconnect power before working on the motor or the pressure switch.**

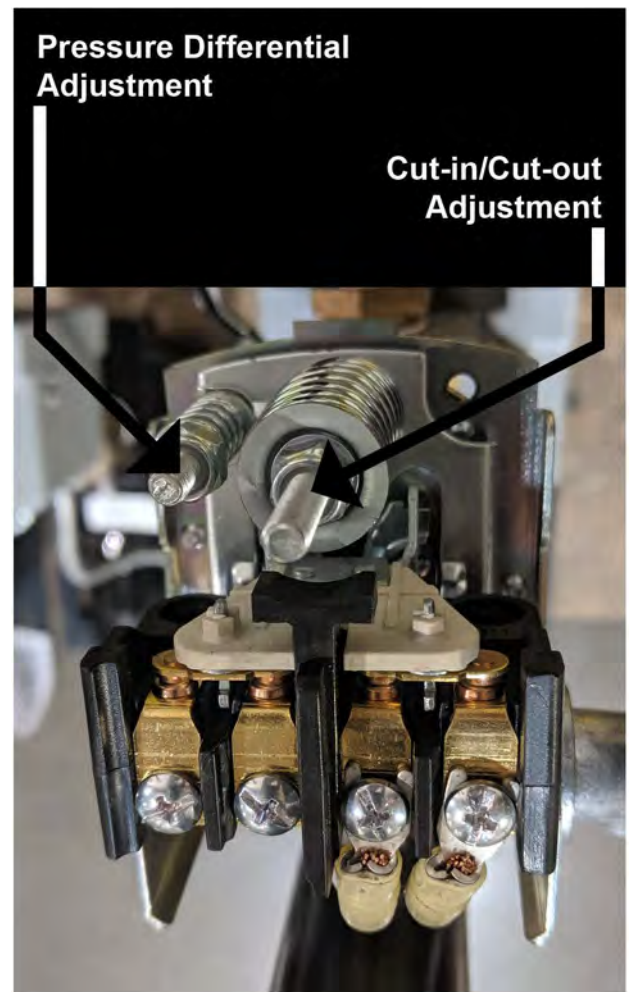

# Home Hydrant Wiring Diagram

230V, 1-Phase supply w/ Ground

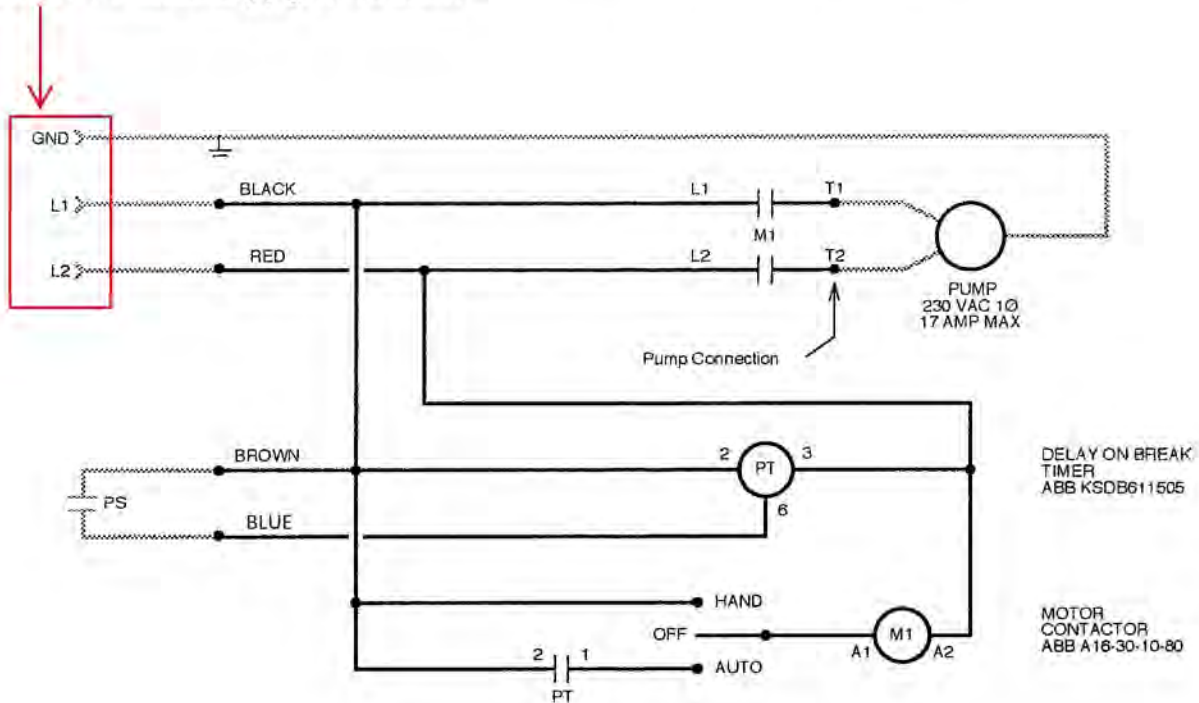

**Connect incoming power (230V 1PH ONLY) to the pre-stripped Red and Black wires only.**

**Connect a dedicated ground to the existing green ground wires in the controller using either the attached lug or other approved method.**

**Do NOT connect a neutral wire.**

**Do NOT alter the Pressure Switch wiring.**

**Do NOT alter any factory wiring.**

**Do NOT attempt to connect any other device to the Control Panel.**

# TALCO FIRE SYSTEMS

## Limited Warranty

All goods are warranted to be free of defects in material and workmanship for a period of one year from start-up or (18) months from the date of shipment, whichever comes first. Except as specifically indicated, TALCO makes no warranties, expressed or implied, oral or written, including, but not limited to, any implied warranty of merchantability or fitness for a particular purpose.

### **THIS WARRANTY IS SPECIFICALLY SUBJECT TO THE FOLLOWING:**

1. The limited warranty is limited to replacement or repair of defective materials and workmanship at the discretion of TALCO.
2. Equipment sold, but not manufactured by TALCO, is subject to the manufacturer's warranty only. TALCO makes no warranties, either expressed or implied, for goods manufactured by others.
3. The limited warranty is conditioned on the purchaser giving TALCO notice within five days of discovery of any alleged defect. Notice should be directed to TALCO FIRE SYSTEMS, by mail: 6040 NE 112th Ave, Portland OR, 97220 or by email: support@talcofire.com.
4. The limited warranty shall be considered null and void if any product or part of the packaged system has been repaired or altered in any way by others without prior authorization from TALCO. Fitting leaks and electrical damage are considered the responsibility of the installing contractor.
5. TALCO shall not be liable for any incidental or consequential loss, damage or expense arising directly or indirectly from the use of any goods subject to this limited warranty, nor shall TALCO be liable for any damages or charges for labor or expense in making repairs or adjustments to the goods. TALCO shall not be liable for any damages or charges sustained in the adaptation or use of its engineering data or services.
6. This warranty shall not apply to any goods subject to misuse due to common negligence or accident, nor to any goods manufactured by TALCO which are not operated in accordance with TALCO printed instructions.
7. The liability of TALCO is limited to material replacements FOB Portland, Oregon.
8. All shipments are FOB TALCO dock and it will be the responsibility of the purchaser to check the goods when they are received and report to the Freight Company any damage that might have occurred.