

# ULR-500

4-383-9

Listed Fire Pump & Controller  
NFPA-20 Compliant Packaged System

# 500GPM

Test Port, City Bypass

## System Components

1	OS&Y Gate Valve
2	Inline Pump & Motor
3	Check Valve
4	Case Relief Valve
5	Monitored Butterfly
6	4" Test Connection
7	Air Release

## Design Conditions

_____ GPM @ _____ PSI
_____ HP _____ V _____ Phase

Project:	
Contractor:	
Date:	P.O.:

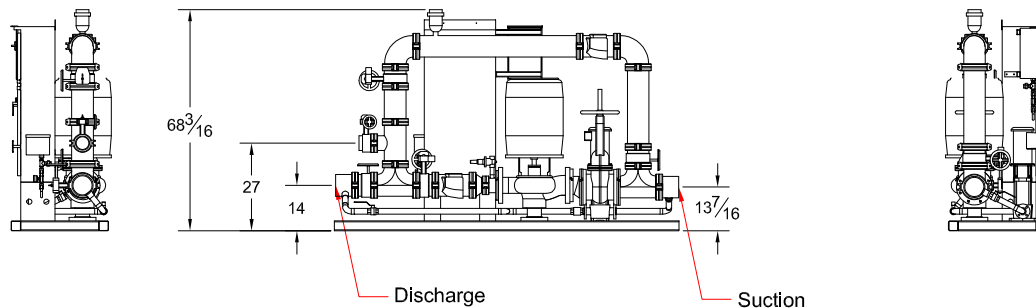
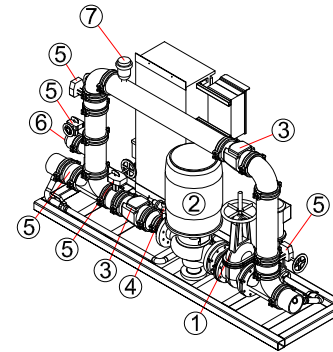
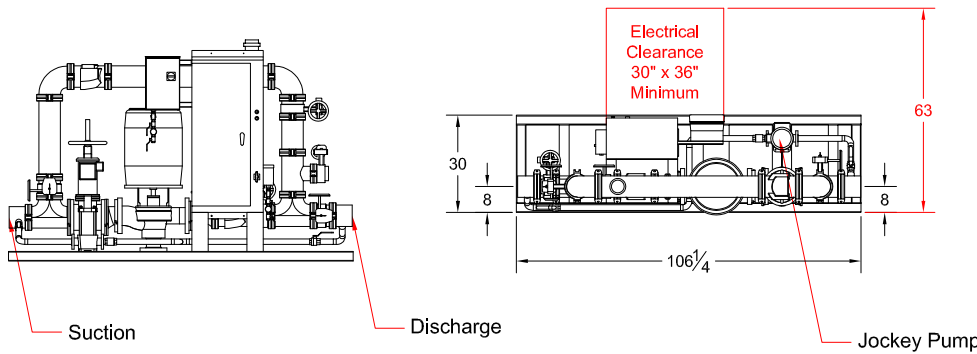

### Jockey System Detail

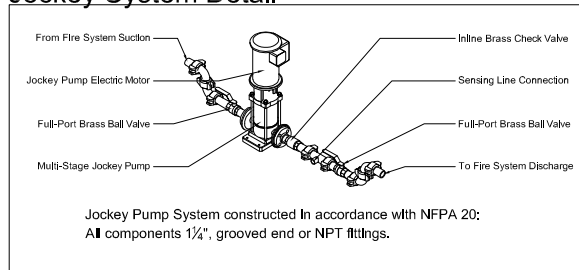

### Sensing Line Detail

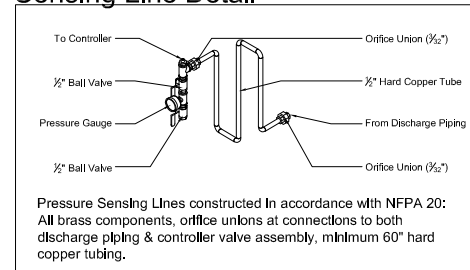

All dimensions inches - Not certified for construction purposes.

Controller: \_\_\_\_\_

Jockey Pump: \_\_\_\_\_

Jockey Controller: \_\_\_\_\_

Suction x Discharge: 6" GRV x 6" GRV

# TALCO FIRE SYSTEMS



RESIDENTIAL & COMMERCIAL FIRE PUMP SPECIALISTS  
6040 NE 112TH AVE. PORTLAND, OREGON 97220  
PHONE: 800-878-8055 WWW.TALCOFIRE.COM