

ULR-200

3-383-9A

Listed Fire Pump & Controller
NFPA-20 Compliant Packaged System

200GPM

Test Port, Flow Meter

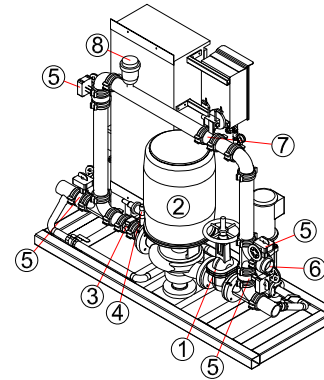
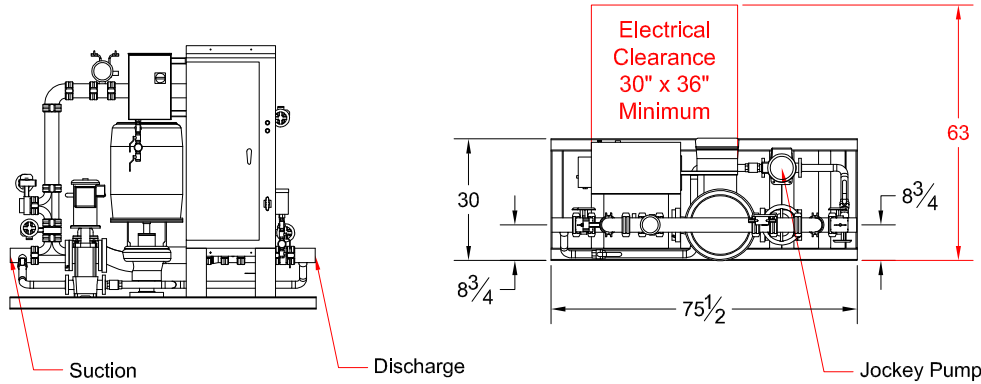

System Components

1	OS&Y Gate Valve
2	Inline Pump & Motor
3	Check Valve
4	Case Relief Valve
5	Monitored Butterfly
6	3" Test Connection
7	Flow Meter
8	Air Release

Design Conditions

_____ GPM @ _____ PSI
_____ HP _____ V _____ Phase

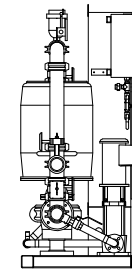
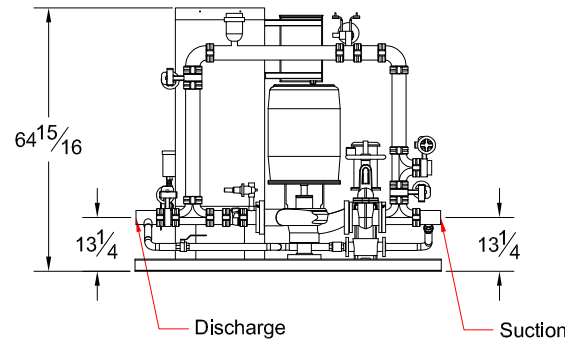
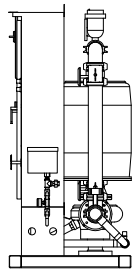

Jockey System Detail

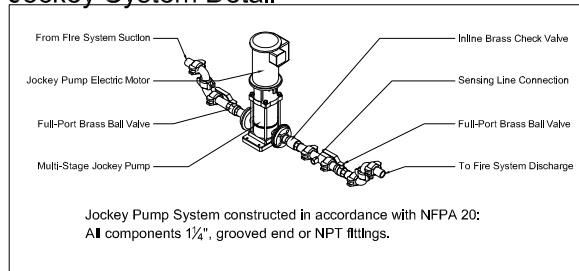

Sensing Line Detail

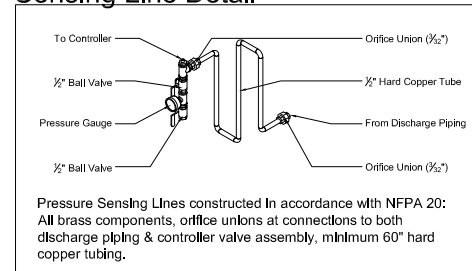

All dimensions inches - Not certified for construction purposes.

Project:	
Contractor:	
Date:	P.O.:

Controller: _____

Jockey Pump: _____

Jockey Controller: _____

Suction x Discharge: 3" GRV x 3" GRV

TALCO FIRE SYSTEMS



RESIDENTIAL & COMMERCIAL FIRE PUMP SPECIALISTS
6040 NE 112TH AVE. PORTLAND, OREGON 97220
PHONE: 800-878-8055 WWW.TALCOFIRE.COM