

HOME HYDRANT

NFPA-13D Packaged Residential Fire Pump & Tank

U.S. Patents #8,678,032 & 8,905,069

HH3-300C

50GPM @ 50PSI

350 Gallon Water Tank

- ① Tank Drain 1/2"(GHT)
- ② Overflow Fitting 1"(FNPT)
- ③ Auto-Fill Valve 3/4"(FNPT)

3HP Electric Motor

240 Volt Single-Phase

13 Amp (Full Load)

1 1/4" Discharge (FNPT)

Smart Riser Control System

- ④ Isolation Ball Valve
- ⑤ Test Line/System Drain
- ⑥ Pressure Gauge
- ⑦ Flow Switch (Optional)
- ⑧ Pressure Switch
- ⑨ Run-Time Controller
- ⑩ Discharge Check Valve
- ⑪ Suction Shut-off Valve

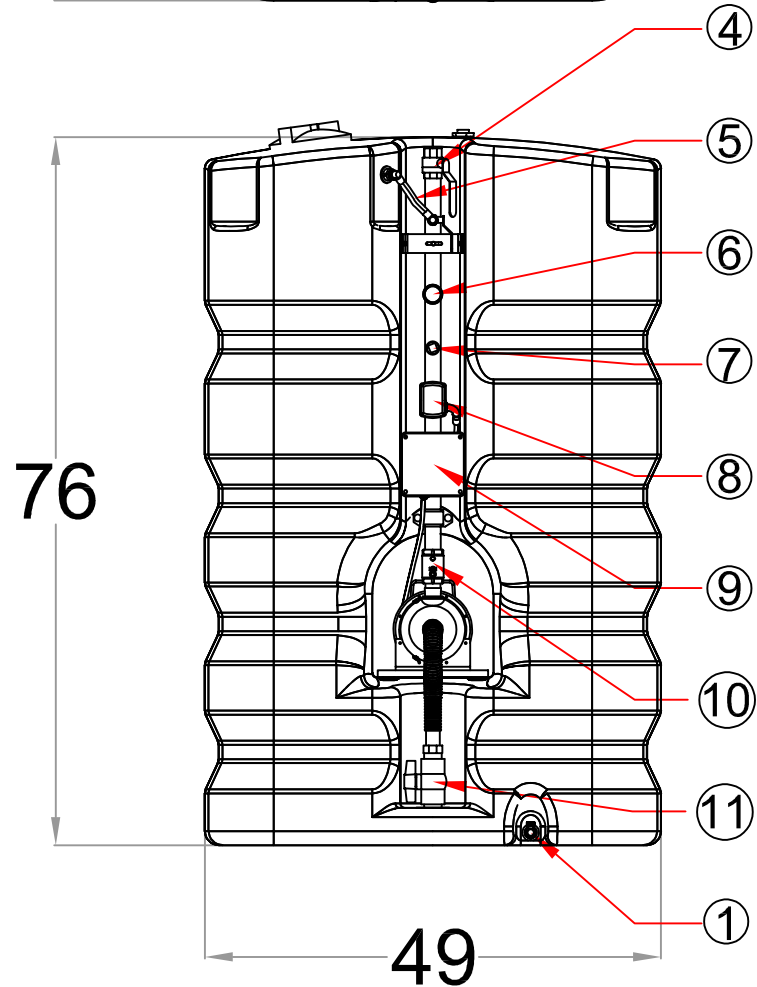
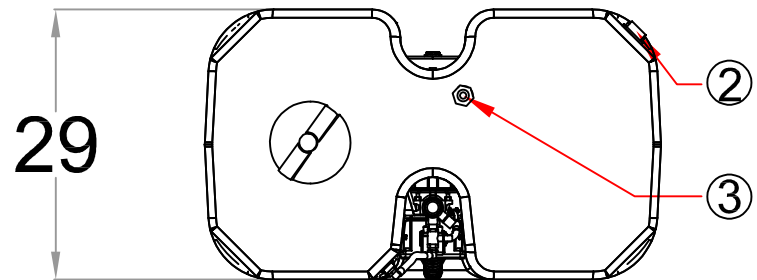

Performance

Performance values based on multiple pump tests. Not for certification purposes.

GPM	0	25	30	35	40	45	50	55
PSI	59	57	55	54	53	51	50	49