

NFPA13R Packaged Fire Pump System
 UL/FM Fire Pump
 with Jockey Pump

13-ULV100

Compact Residential Package
 Design Condition: 100GPM @ 80PSI

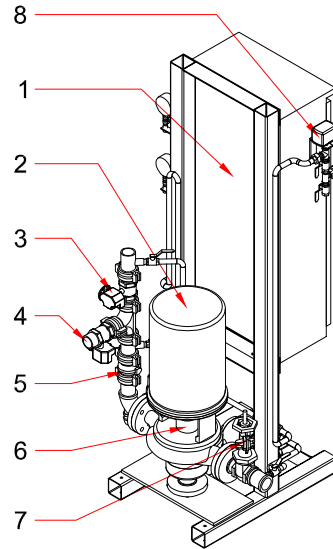
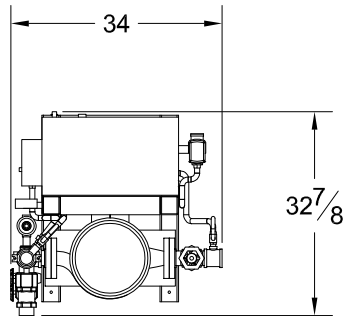

System Specifications:

- Motor**
 -10 Horsepower Electric
 -230 Volt, 46 Amp
 -Single Phase
 -3450 RPM

- Pump**
 -UL/FM Vertical Inline Fire Pump
 -2" Suction (FNPT)
 -2" Discharge (Grooved)
 -175 PSI max working pressure

System Components (UL Listed by Manufacturer)

- 1- Limited Service Fire Pump Controller
- 2- Electric Motor
- 3- Discharge Monitored Ball Valve
- 4- Test Connection Monitored Ball Valve
- 5- Check Valve
- 6- Vertical Inline Fire Pump
- 7- Suction OS&Y
- 8- Pressure Switch (Jockey Control)

Dimensions (Approximate)

- 33" Depth
- 78" Height
- 34" Width

