

ULR-100

w/Test Port, Jockey Pump
Listed Fire Pump & Controller
NFPA-20 Compliant Packaged System

Controller: _____

Jockey Pump: _____

Jockey Controller: _____

Suction x Discharge: 2" GRV x 2" GRV

100GPM

2 x 2 - 9C

PSI (range)	Motor HP
66-80	10
81-115	15
116-130	20
131-150	25

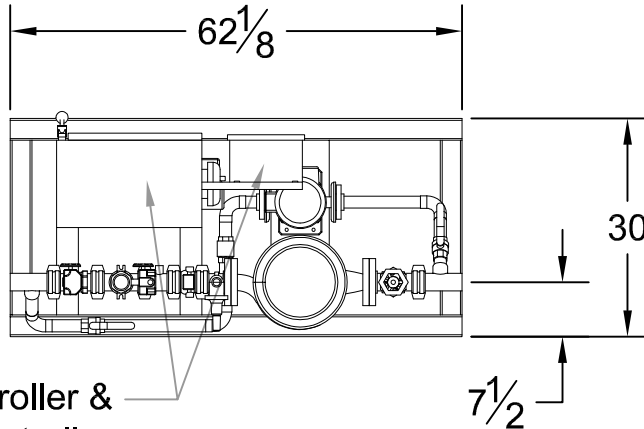

Main Controller & Jockey Controller

DESIGN CONDITIONS
 _____ GPM @ _____ PSI
 _____ HP _____ V _____ Phase

Project: _____
 Contractor: _____
 Date: _____ P.O.: _____

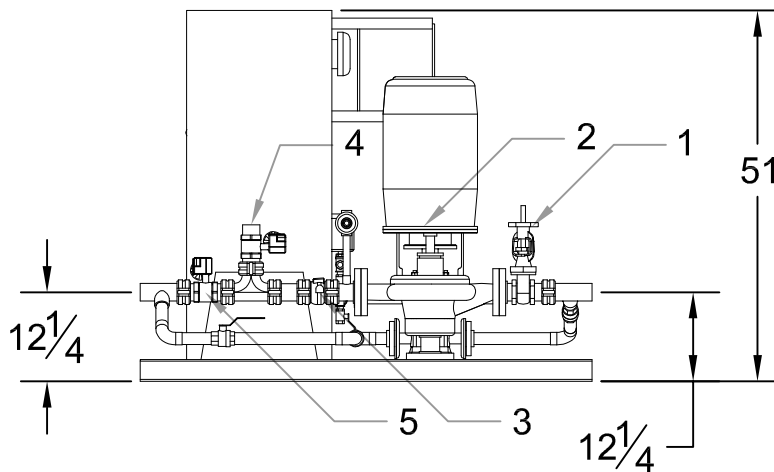

System Components

1	OS&Y Gate Valve
2	Inline Pump & Motor
3	Check Valve
4	Test Port Connection
5	Monitored Butterfly

Approximate ship weight: < 900#