

HOME HYDRANT - **FOR POTABLE WATER SYSTEMS**

NFPA-13D Packaged Residential Fire Pump & Tank

U.S. Patents #8,678,032 & 8,905,069

HH3-PW

50GPM @ 50PSI

350 Gallon Water Tank

- ① Tank Drain 1/2"(GHT)
- ② Overflow Fitting 1"(FNPT)
- ③ Auto-Fill Valve 3/4"(FNPT)

3HP Electric Motor
 240 Volt Single-Phase
 13 Amp (Full Load)

1 1/4" Discharge (FNPT)
 Smart Riser Control System

- ④ Isolation Ball Valve
- ⑤ Test Line/System Drain
- ⑥ 40-60 Pressure Switch
- ⑦ Pressure Gauge
- ⑧ Discharge Check Valve
- ⑨ Suction Shut-off Valve

Included with Potable Water Systems -
 (1) Home Hydrant Tank and Stainless Steel Pump
 (1) PW Safe Discharge Manifold (no flow switch included)

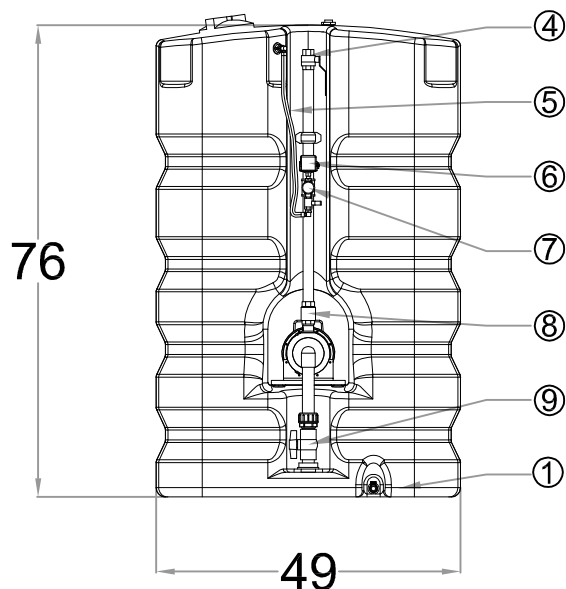
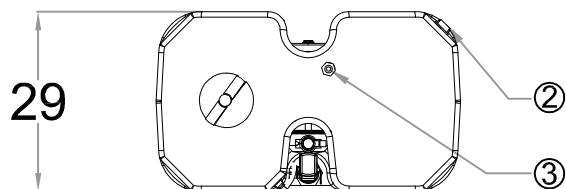

Pump Performance

All dimensions inches.
 Performance values based on multiple pump tests. Not for certification purposes.

GPM	0	25	30	35	40	45	50	55
PSI	59	57	55	54	53	51	50	49

HOME HYDRANT - **FOR POTABLE WATER SYSTEMS**

NFPA-13D Packaged Residential Fire Pump & Tank

U.S. Patents #8,678,032 & 8,905,069

HH3-PWPT

50GPM @ 50PSI

350 Gallon Water Tank

- ① Tank Drain 1/2"(GHT)
- ② Overflow Fitting 1"(FNPT)
- ③ Auto-Fill Valve 3/4"(FNPT)
- ④ 85 Gallon Bladder Tank

3HP Electric Motor
240 Volt Single-Phase
13 Amp (Full Load)

1 1/4" Discharge (FNPT)
Smart Riser Control System

- ⑤ Isolation Ball Valve
- ⑥ Test Line/System Drain
- ⑦ 40-60 Pressure Switch
- ⑧ Pressure Gauge
- ⑨ Discharge Check Valve
- ⑩ Suction Shut-off Valve

Included with Potable Water Systems -
(1) Home Hydrant Tank and Stainless Steel Pump
(1) PW Safe Discharge Manifold (no flow switch included)
(1) 85 Gallon PW Safe Bladder Tank

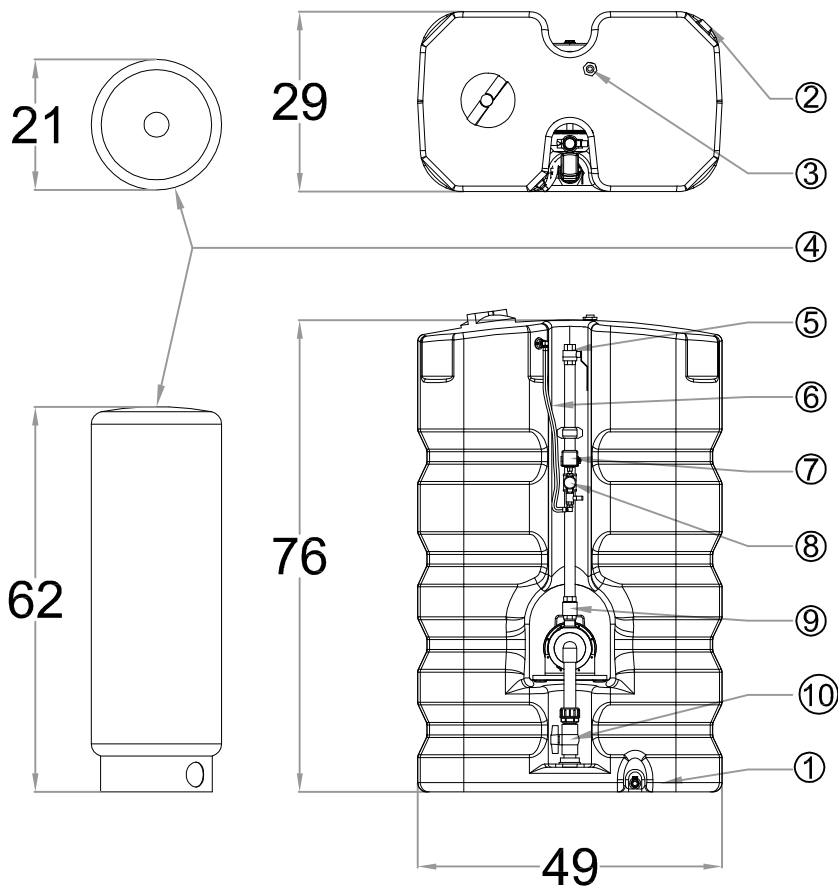

Pump Performance

All dimensions inches.
Performance values based on multiple pump tests. Not for certification purposes.

GPM	0	25	30	35	40	45	50	55
PSI	59	57	55	54	53	51	50	49