

# HOME HYDRANT BRAND FIRE PUMP SYSTEM

NFPA-13D Packaged Residential Fire Pump & Tank  
 U.S. Patents #8,678,032 & 8,905,069

## HH3-300C

50GPM @ 50PSI

350 Gallon Water Tank

- ① Tank Drain 1/2"(GHT)
- ② Overflow Fitting 1"(FNPT)
- ③ Auto-Fill Valve 3/4"(FNPT)

3HP Electric Motor

240 Volt Single-Phase  
 13 Amp (Full Load)

1 1/4" Discharge (FNPT)  
 Smart Riser Control System

- ④ Isolation Ball Valve
- ⑤ Test Line/System Drain
- ⑥ 40-60 Pressure Switch
- ⑦ Pressure Gauge
- ⑧ Flow Switch
- ⑨ Run-Time Controller
- ⑩ Discharge Check Valve
- ⑪ Suction Shut-off Valve

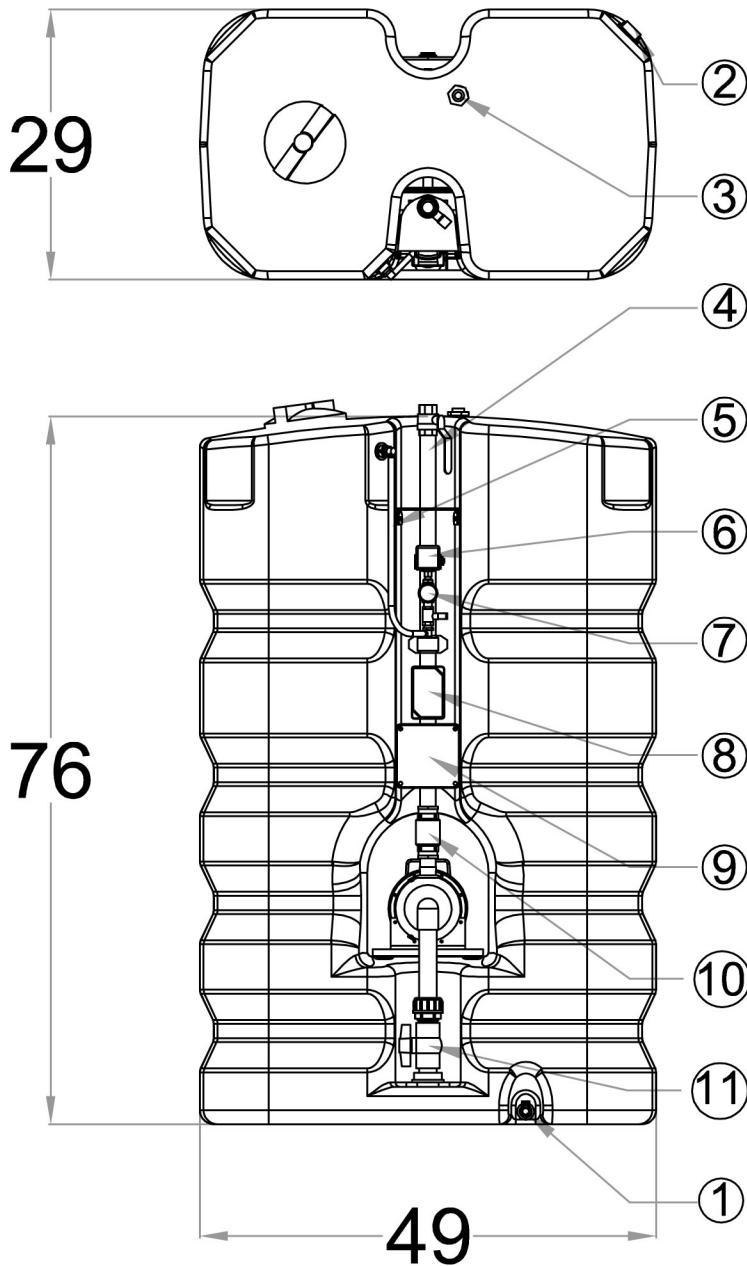

## Performance

Performance values based on multiple pump tests. Not for certification purposes.

GPM	0	25	30	35	40	45	50	55
PSI	59	57	55	54	53	51	50	49