

ULR-50

w/Test Port, Jockey Pump
Listed Fire Pump & Controller
NFPA-20 Compliant Packaged System

Controller: _____

Jockey Pump: _____

Jockey Controller: _____

Suction x Discharge: 2" GRV x 2" GRV

50GPM

2 x 2 - 9C

PSI (range)	Motor HP
75-95	10
96-120	15
121-135	20
136-155	25

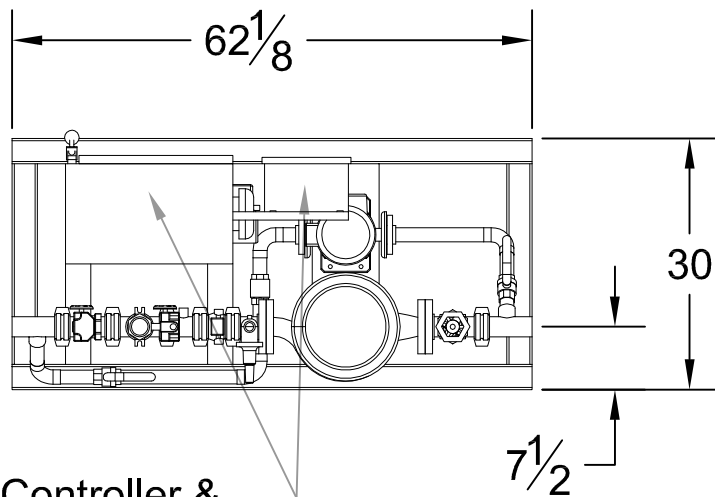

Main Controller &
Jockey Controller

DESIGN CONDITIONS	
_____ GPM @ _____ PSI	
_____ HP _____ V _____ Phase	

Project: _____	
Contractor: _____	
Date: _____	P.O.: _____

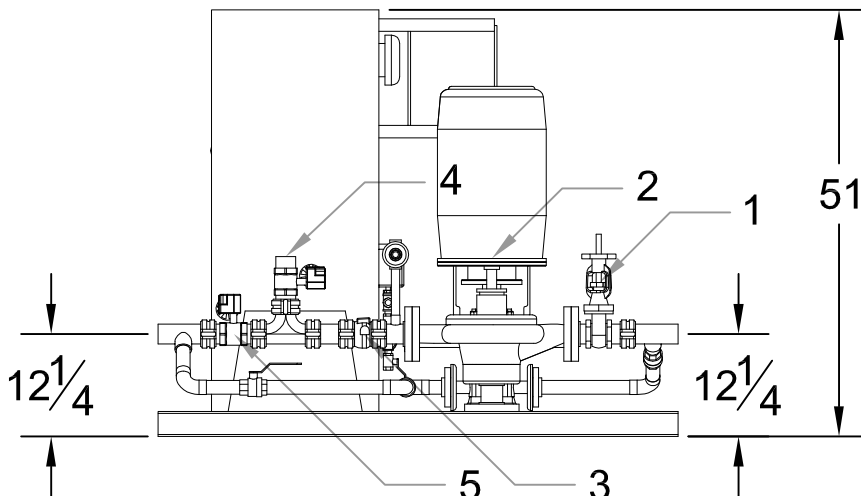

System Components	
1	OS&Y Gate Valve
2	Inline Pump & Motor
3	Check Valve
4	Test Port Connection
5	Monitored Butterfly

Approximate ship weight: < 900#