

HOME HYDRANT U.S. Patents #8,678,032 & 8,905,069

NFPA-13D Packaged Residential Fire Pump & Tank

HH4-200W

40GPM @ 40PSI

450 Gallon Water Tank

- ① Tank Drain 1/2"(GHT)
- ② Overflow Fitting 1"(FNPT)
- ③ Auto-Fill Valve 3/4"(FNPT)

2HP Electric Motor

240 Volt Single-Phase
9 Amp (Full Load)

1 1/4" Discharge (FNPT)

Smart Riser Control System

- ④ Isolation Ball Valve
- ⑤ Test Line/System Drain
- ⑥ 40-60 Pressure Switch
- ⑦ Pressure Gauge
- ⑧ Flow Switch
- ⑨ Discharge Check Valve
- ⑩ Suction Shut-off Valve

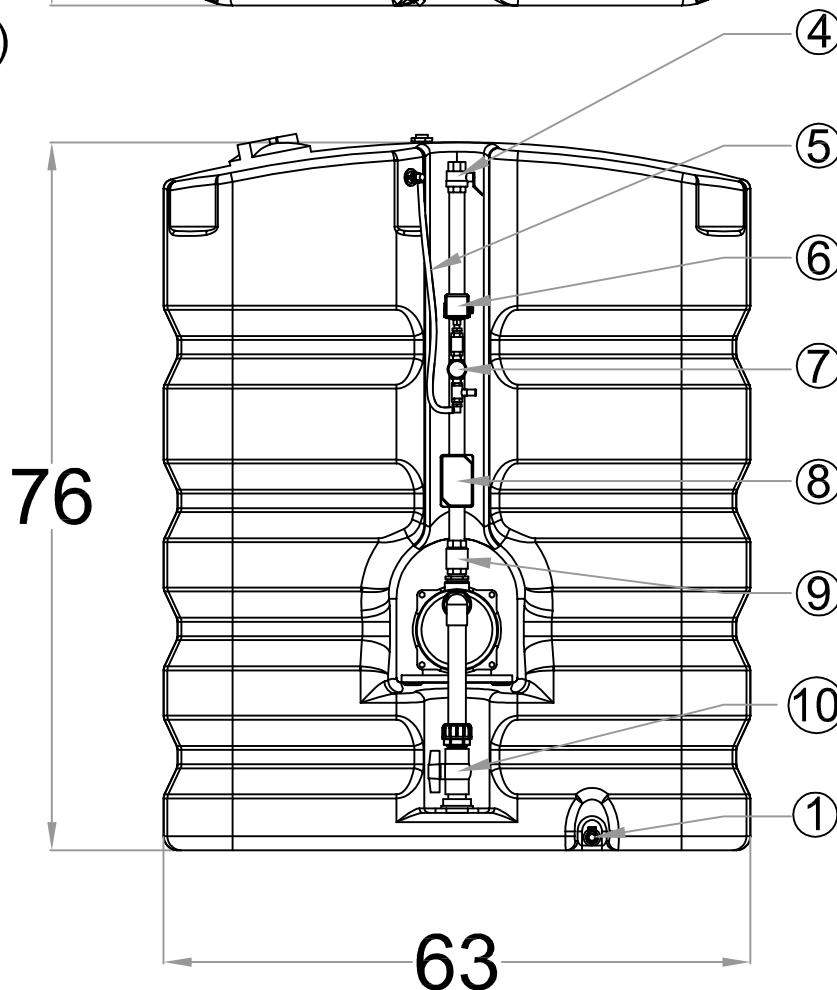
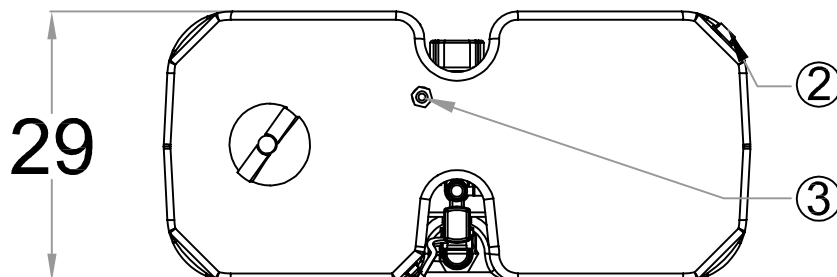

Performance

Performance values based on multiple pump tests. Not for certification purposes.

GPM	0	20	30	40	50	60
PSI	49	47	45	42	36	29